



Domino Storage Optimizer (DSO)

proClients GmbH

Phone: +49 2133 26890

Mail: info@proclients.de



Domino Storage Optimizer

Centera

Situation today



- Increasing storage cost
 - Decreasing cost of hardware, but ...
 - Data volume rises faster
- Increasing handling cost
 - Backups
- >80% of Mail-Server-Storage used for attachments
- Redundancy of attachments
 - Mail to many internal recipients
 - Same attachment to many different external recipients
 - Reply to, reply to, ...

Domino Storage Optimizer

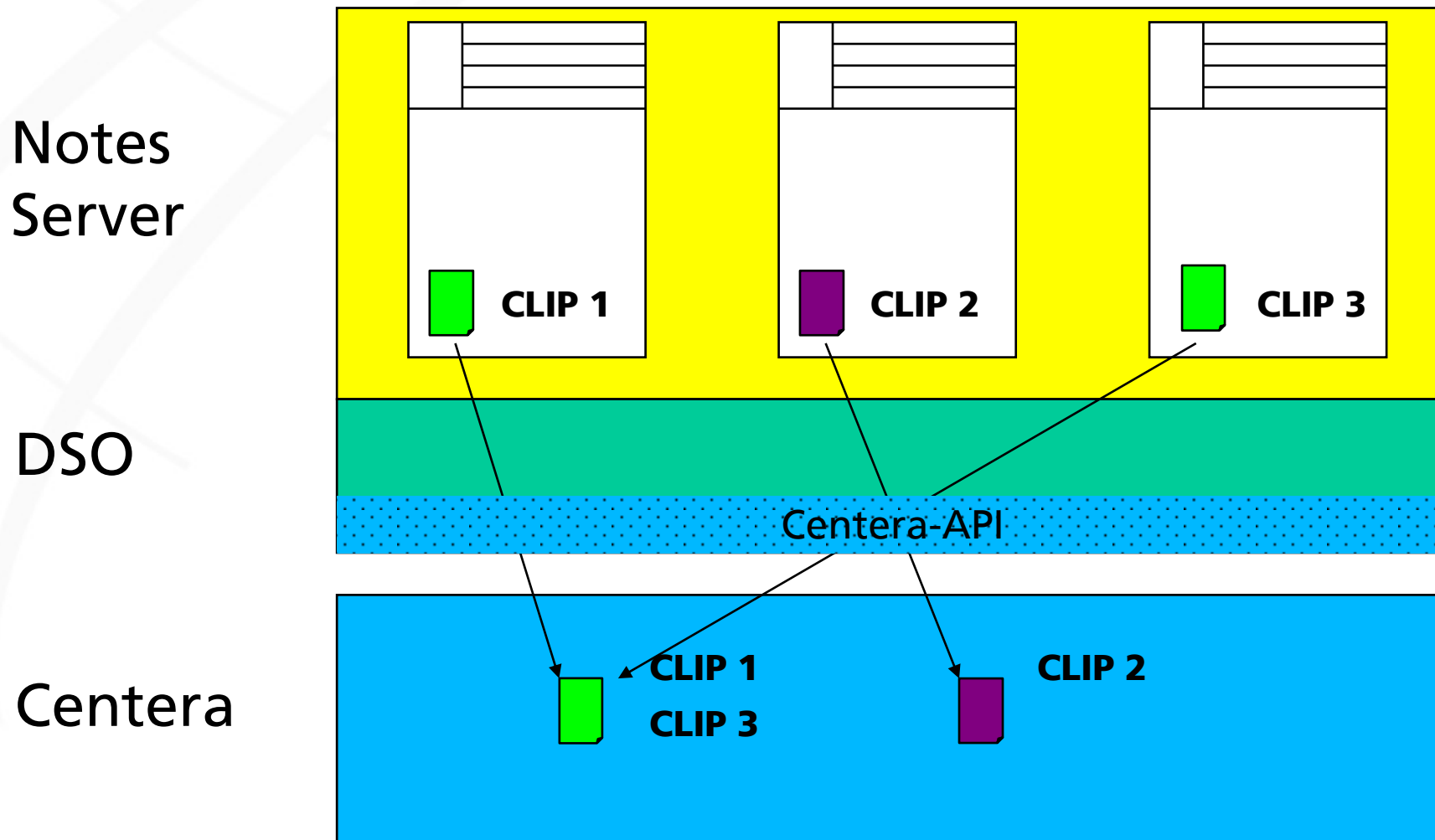

How it works

- DSO copies attachments from Domino databases to the Centera
- Centera generates for each attachment a unique reference, named CLIP
- DSO stores CLIP's in the Notes databases and deletes the objects
- Centera recognizes identical files (by hash values) and stores them only once
- Access of attachments in Notes databases forces the DSO to store them back

Domino Storage Optimizer

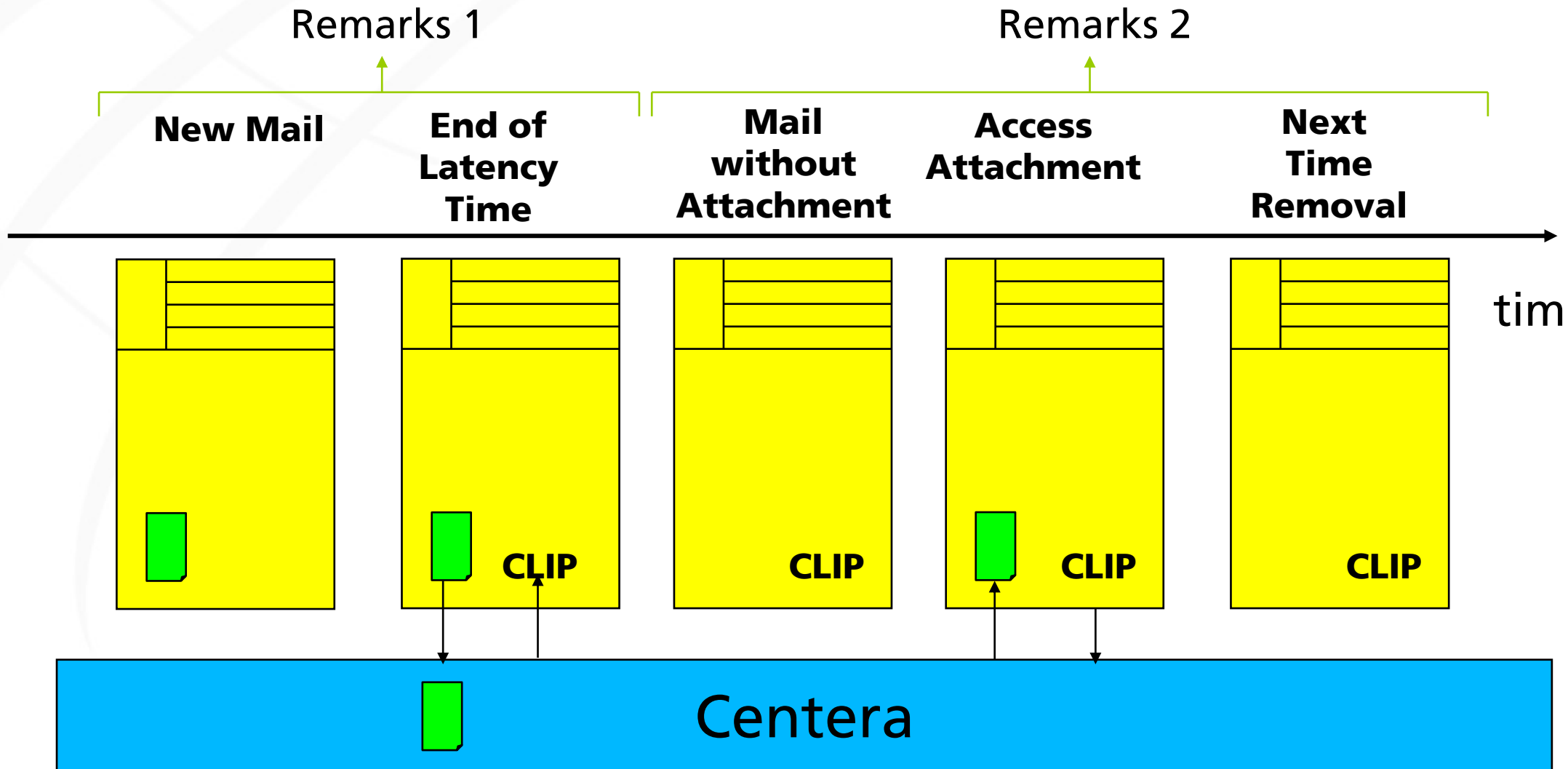

Remarks 1

- New mail with attachment
 - After retention time DSO moves the attachment to the Centera
 - The latency time **turns** the Notes database **into** a “time controlled cache for attachments”
 - Access rate decreases strong over time
 - Saves resources (Server, Network, Centera)

Remarks 2

- Access of attachment
 - Attachment automatically fetched from Centera and stored to the Notes database
 - Absolutely seamless for the user
 - Very fast
- Attachment will be deleted next time Removal from Storage-Agent runs
- Changed attachments are stored to the Centera
 - Old version will be deleted

DSO and Replication



Status **before** removal of attachment

Cluster

Local
Replica

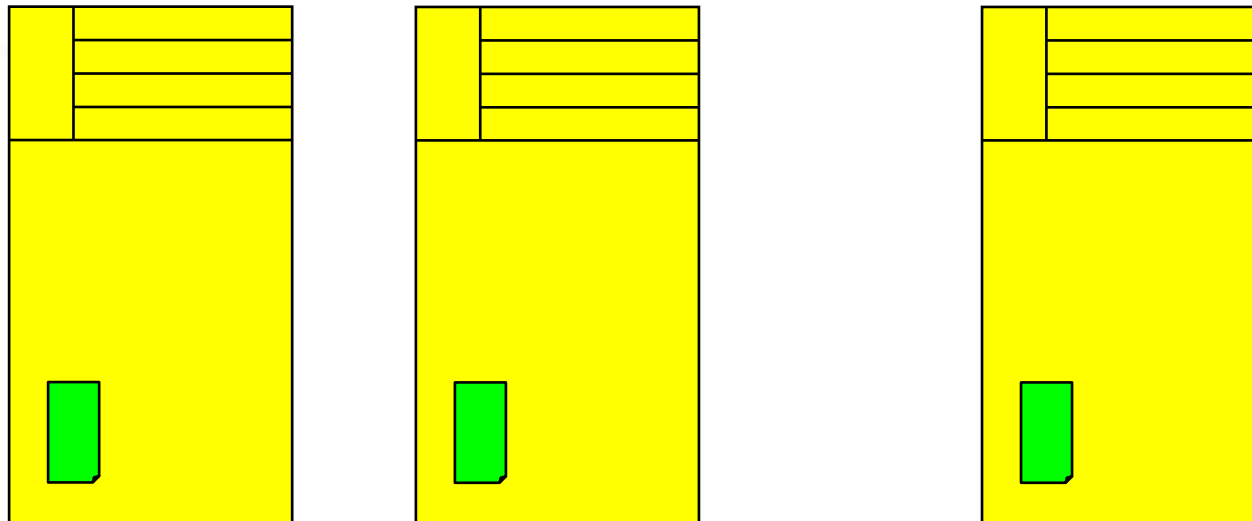

DSO and Replication



Status **after** removal of attachment

Cluster

Local
Replica

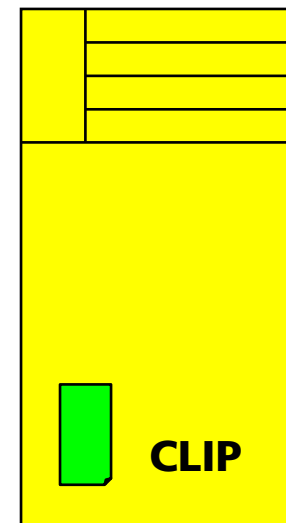
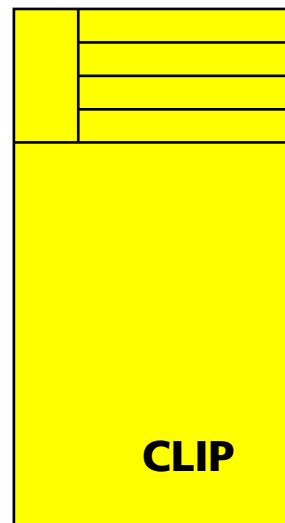
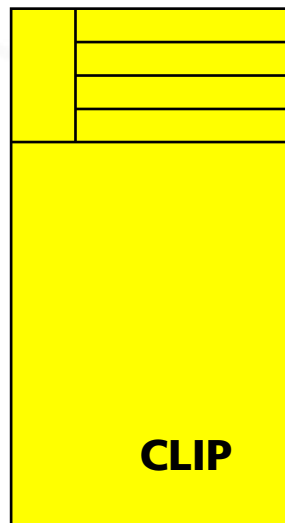

Domino Storage Optimizer

- Identical impact on signed and/or encrypted Notes documents
- Signatures remain untouched
- Fulltext index contains complete information, even for objects moved to the Centera
 - Creation of a new fulltext index restores objects at runtime and removes them after the indexer is done
- Newly created replicas contain all objects
- Full support for BlackBerry users

Domino Storage Optimizer

- Shows very fast benefits
 - Enormous storage reduction
 - Substantial less backup effort
- Elimination of redundancy reduces overall data amount
- Pure Server-Implementation
 - No database template modification
 - No rollout
 - No education for end users
- Simple and fast configuration for mass databases (directory based)

Domino Storage Optimizer

- Performance figures
 - Single largest optimized Domino Server with 3.300 DB's
 - Largest installation with over 6.000 DB's distributed over several Domino Clusters working against a single Centera-System
- Common facts:
 - No noticeable delays when accessing attachments
 - No noticeable increase of server load
 - Very low administration effort
 - Easy and fast implementation

Domino Storage Optimizer

- Licensing per database, regardless of number of servers
40,- Euro per database decreasing with number of licenses
- A clustered database needs only one license
- Usable any Domino database (Mail or Application)
- No changes on database templates
- Admin-Tool
 - Configuration of systems and databases
 - Setup of single databases
 - Mass configuration (all databases in a directory) with automatic matching check (configuration against directory content)
 - Reload all attachments to a database
 - Delete all CLIPS of one database in the Centera

Technology



- Java Agents
 - Attachment removal
 - Administrative functions
- Extension Manager (C-API)
 - Attachment Restore

Supported Platforms



- Domino version 6 or higher
 - Windows-platform
 - LINUX
 - AIX
 - Solaris

Forward Look to Mail Integration with DMS or electronic Archives



- Move and store relevant documents to common shared repositories (DMS)
 - E.g. customer folders, product folders, ...
 - Documents with common content
- For a DMS, mailboxes are only an additional document source
 - The content determines the place for filing – not the form (Word, E-Mail, Image, ...)
- This generates the biggest advantage for every organization
- DMS projects are much more organizational projects than IT projects

Mail-Integration

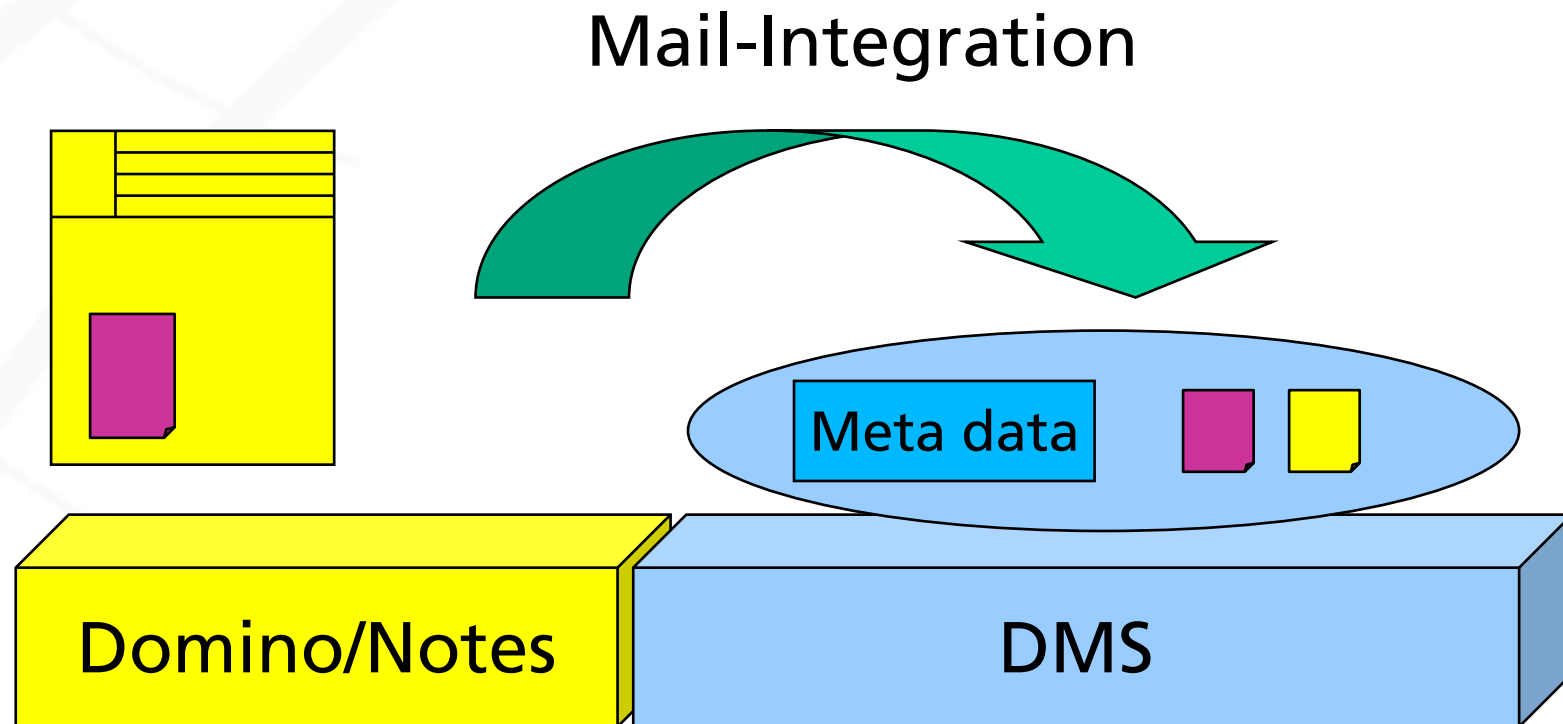

DSO and Mail-Integration

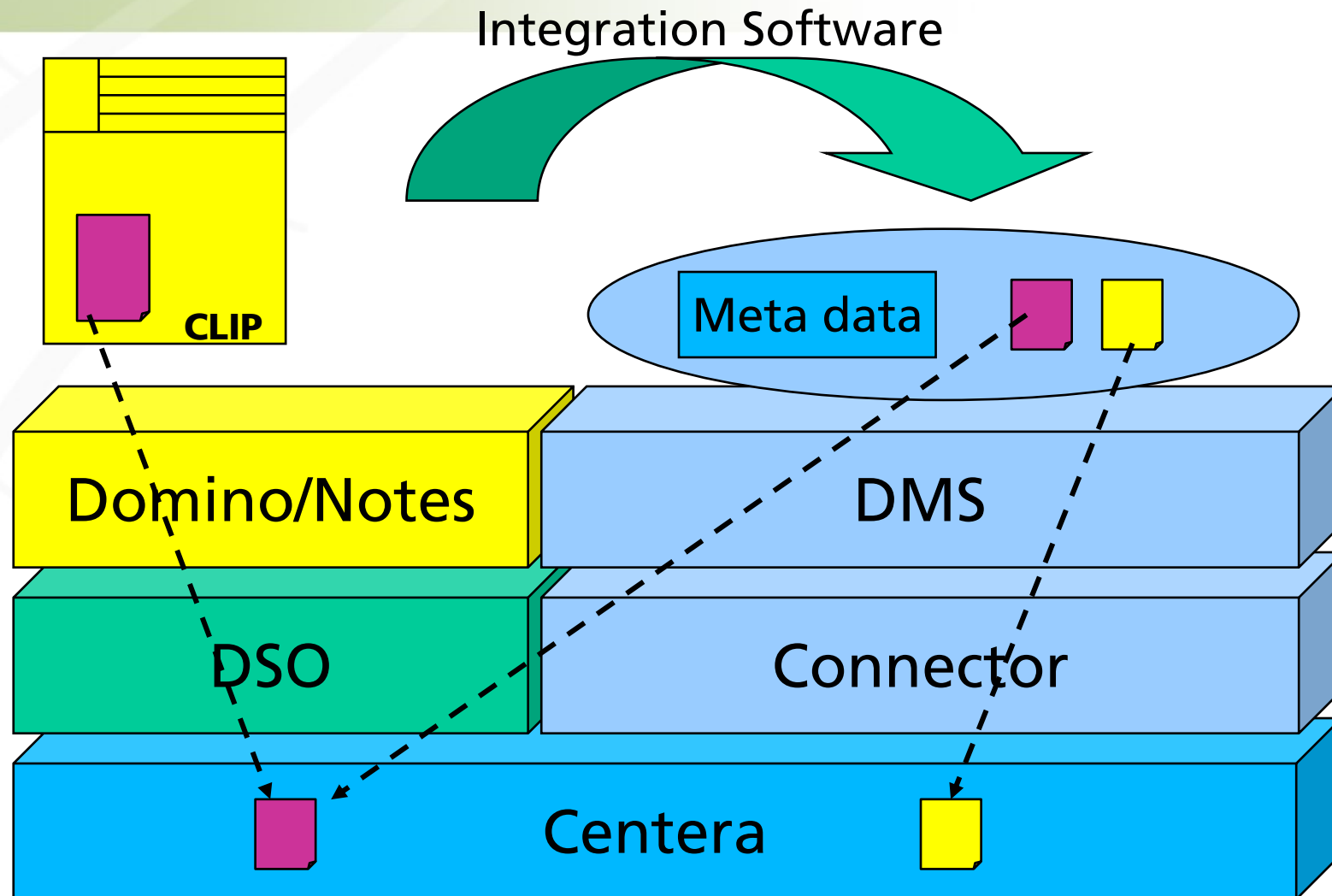

Thanks very much for your
attention



Domino Storage Optimizer

Centera

Please don't hesitate to ask any questions or let us know
your requirements and needs.